125 K

EN 14439:2009 – C25
Technical Data

LIEBHERR

Tower Cranes

CE | UK
CA

125 K

Kranbetrieb und Transport · Crane operation and transport Exploitation de la grue et transport · Funzionamento della gru e trasporto Accionamiento de grúa y transporte · Operação e transporte de guindastes Эксплуатация крана и транспортировка	04
Gewichte · Weights · Poids · Pesi · Pesos · Pesos · Macca.....	04
Ausladung und Tragfähigkeit · Radius and capacity · Portée et charge Sbraccio e portata · Alcances y cargas · Alcance e capacidade de carga Вылет и грузоподъемность.....	06
Antriebe · Driving units · Mécanismes d'entraînement · Meccanismi Mecanismos · Mecanismos · Приводы	06
Aufstellvorgang · Erection procedure · Déroulement de montage Procedimento di montaggio · Procedimiento de montaje · Sistema de montagem Процесс развертывания	07
Kolli-Liste · Packing List · Liste de colisage · Lista dei colli · Lista de contenido Lista de embalagem · Упаковочный лист	07

Kranbetrieb und Transport - Crane operation and transport - Exploitation de la grue et transport - Funzionamento della gru e trasporto - Accionamiento de grúa y transporte - Operação e transporte de guindastes - Эксплуатация крана и транспортировка

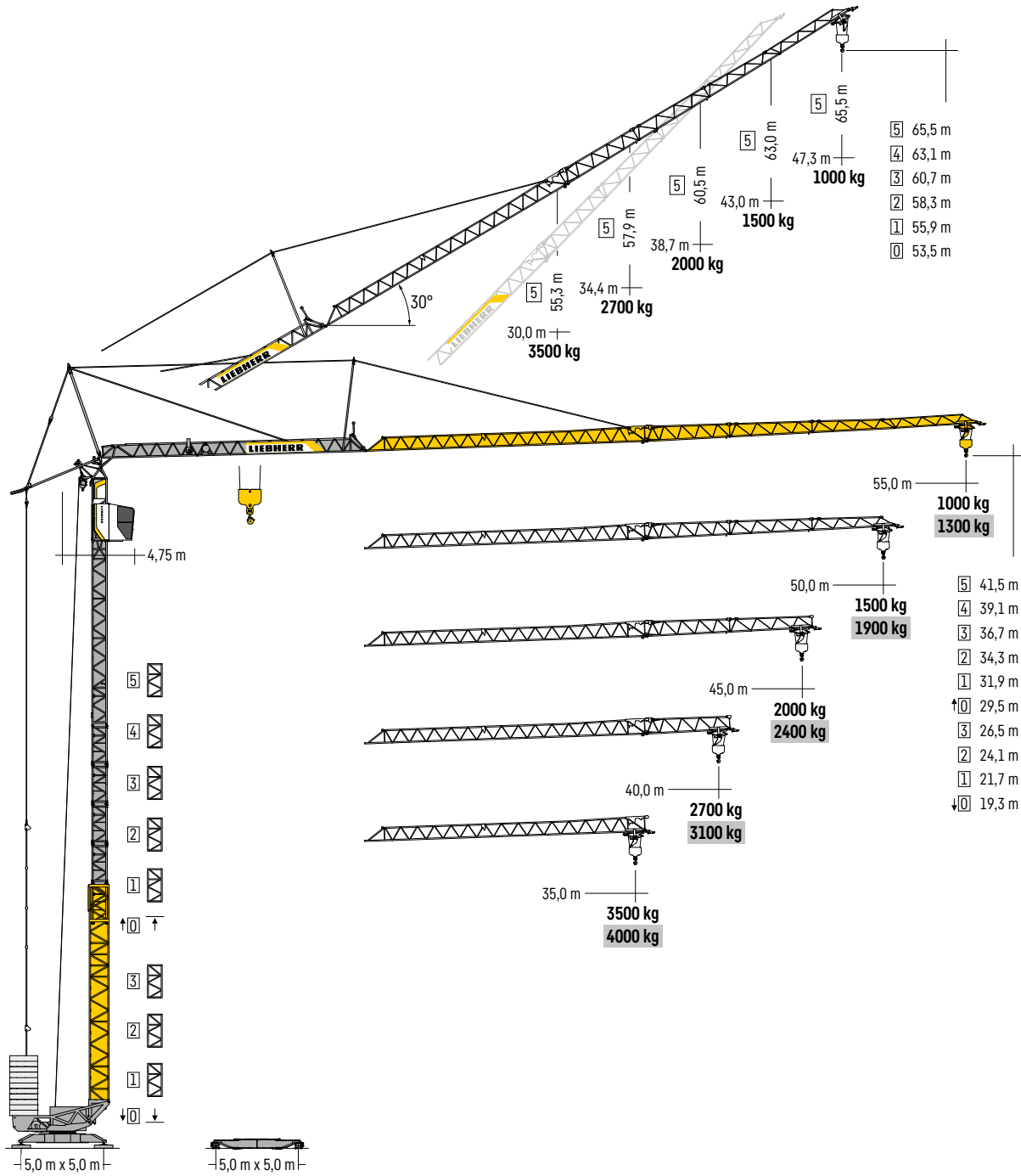

Gewichte - Weights - Poids - Pesi - Pesos - Pesos - Macca

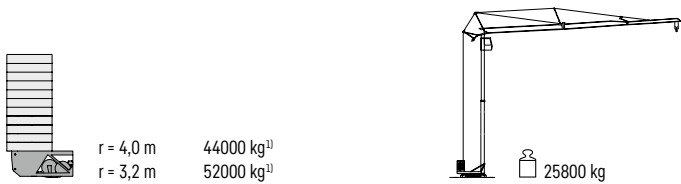

¹⁾ Siehe Betriebsanleitung. - See instruction manual. - Voir manuel de service. - Vedi manuale d'istruzione. - Ver manual de instrucción. - Ver manual de instruções. - См. инструкцию по эксплуатации.

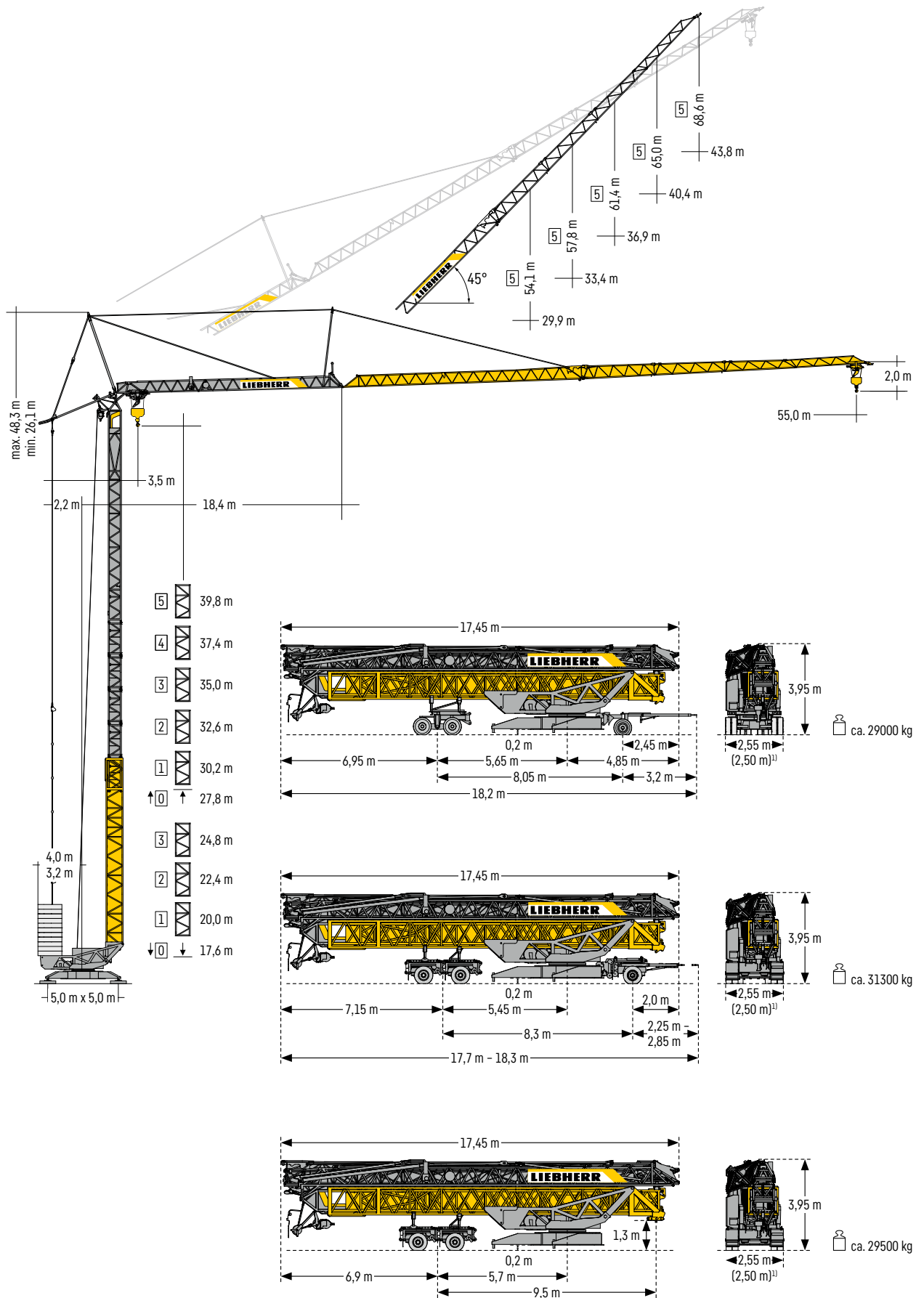

Ausladung und Tragfähigkeit · Radius and capacity · Portée et charge · Sbraccio e portata Alcances y cargas · Alcance e capacidade de carga · Вылет и грузоподъемность

Load-Plus

m	m	kg	m															
			8,0	12,0	16,0	20,0	24,0	28,0	32,0	35,0	38,0	40,0	42,0	45,0	48,0	50,0	52,0	55,0
55,0	3,5 - 8,9	8000	8000	6320	4950	4030	3370	2880	2500	2260	2060	1940	1830	1680	1550	1470	1400	1300
50,0	3,5 - 10,3	8000	8000	7170	5750	4770	4060	3510	3080	2810	2580	2440	2310	2140	1990	1900		
45,0	3,5 - 12,2	8000	8000		6480	5360	4540	3930	3440	3140	2880	2730	2590	2400				
40,0	3,5 - 14,5	8000	8000		7380	6090	5150	4450	3900	3560	3270	3100						
35,0	3,5 - 16,3	8000	8000			6740	5730	4970	4370	4000								

→ kg

LM 1

m	m	kg	m															
			8,0	12,0	16,0	20,0	24,0	28,0	32,0	35,0	38,0	40,0	42,0	45,0	48,0	50,0	52,0	55,0
55,0	3,5 - 8,9	8000	8000	6010	4510	3560	2910	2440	2080	1860	1680	1570	1470	1340	1220	1150	1090	1000
50,0	3,5 - 10,3	8000	8000	6970	5330	4280	3540	3000	2590	2330	2120	1990	1870	1720	1580	1500		
45,0	3,5 - 12,2	8000	8000		6190	4950	4090	3470	2990	2700	2450	2310	2180	2000				
40,0	3,5 - 14,5	8000	8000		7250	5780	4770	4040	3490	3150	2870	2700						
35,0	3,5 - 16,3	8000	8000			6460	5320	4500	3880	3500								

→ kg

Auslegerstellung 30° · Jib position 30° · Position de flèche 30° · Posizione del braccio 30° Posición de la pluma 30° · Posição da lança 30° · Положение стрелы 30°

m	m	kg	m															
			8,0	12,0	16,0	20,0	24,0	28,0	30,0	32,0	34,4	36,0	38,0	38,7	42,0	43,0	46,0	47,3
55,0	3,5 - 15,5	4000	4000		3870	3030	2460	2040	1870	1730	1570	1480	1370	1340	1190	1150	1040	1000
50,0	3,5 - 18,5	4000	4000			3680	3030	2540	2350	2170	1990	1880	1760	1720	1550	1500		
45,0	3,5 - 21,3	4000	4000				3500	2950	2720	2520	2310	2190	2050	2000				
40,0	3,5 - 24,6	4000	4000					3450	3180	2940	2700							
35,0	3,5 - 27,4	4000	4000						3870	3500								

→ kg

Load-Plus = Abweichende Geschwindigkeiten und Betriebsbedingungen. · Variant speeds and service conditions. · Vitesses et conditions de fonctionnement différentes.
Differenti velocità e condizioni di funzionamento. · Otras velocidades y características de funcionamiento. · Outras velocidades e características de funcionamento.
Нестандартные скорости и условия эксплуатации.

Antriebe · Driving units · Mécanismes d'entraînement · Meccanismi Mecanismos · Mecanismos · Приводы

18 kW FU

stufenlos · stepless
régl. continu · regl. progressiva
sin escalones · sem degraus
бесступенчатый

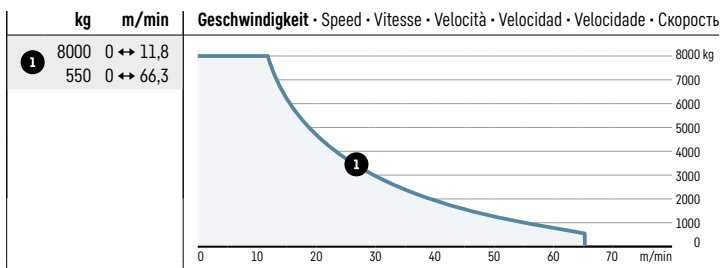

BGL

C.O.03.0125

 0 ↔ 0,8 U/min · sL./min · tr./min 7,5 kW FU	 0 ↔ 71 m/min 3,7 kW FU	 0 ↔ 23 m/min 2 x 3,0 kW FU	 0 - 45°, 105 sec. 4,0 kW FU	 380 - 440 V	 50 - 60 Hz	 26,0 kVA (FU)
--	-------------------------------	-----------------------------------	------------------------------------	-----------------	----------------	-------------------

Aufstellvorgang • Erection procedure • Déroulement de montage • Procedimento di montaggio Procedimiento de montaje • Sistema de montagem • Процесс развертывания

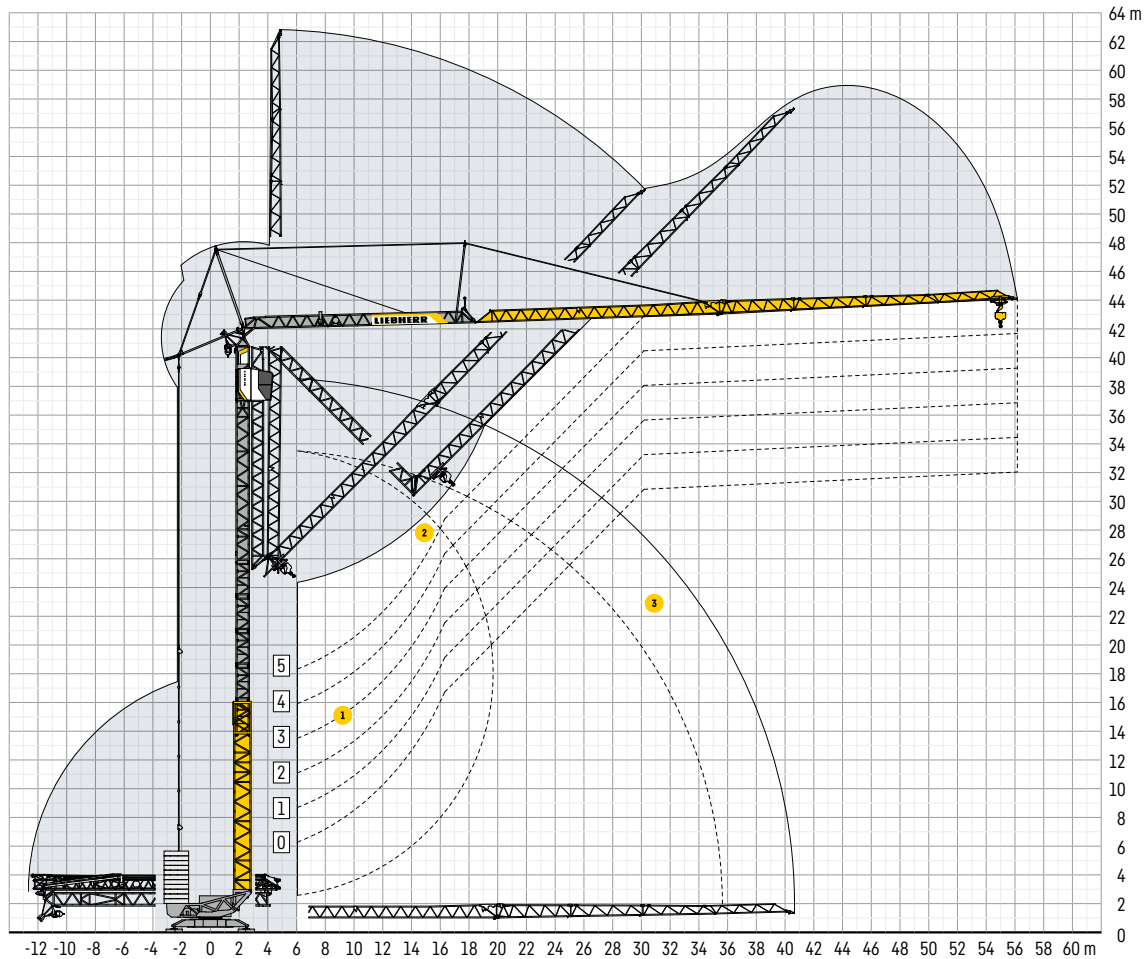









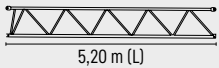
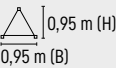

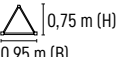

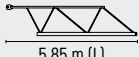
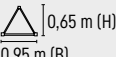

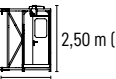

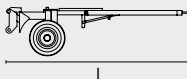

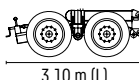
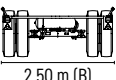
- 1 **Standard Aufstellkurven von 0 bis 5 Turmstücken (50 m)** • Standard erecting curves from 0 to 5 tower sections (50 m) • Courbes de montage standard de 0 à 5 éléments de mât (50 m) • Curve di montaggio standard con 0 fino a 5 elementi torre (50 m) • Curvas de montaje estándar (0 - 5 tramos de torre) (50 m) • Curvas padrão de montagem de 0 até 5 segmentos de torre (50 m) • Стандартная монтажная высота с 0 - 5 башенными секциями (50 м)
- 2 **Erhöhte Aufstellkurve (+6 m) am Beispiel von 5 Turmstücken (50 m)** • Elevated erecting curve (+6 m) using the example of 5 tower sections (50 m) • Courbe de montage élevée (+6 m) en prenant pour exemple 5 éléments de mât (50 m) • Elevata curva di montaggio (+6 m), come per esempio con 5 elementi di torre (50 m) • Curva de montaje elevada (+6 m): ejemplo con 5 tramos (50 m) • Curva elevada de montagem (+6 m) como exemplo para 5 segmentos de torre (50 m) • Увеличенная монтажная высота (+6 м) на примере 5-ти башенных секций (50 м)
- 3 **Aufstellkurve 55 m Ausladung** • Erecting curve 55 m radius • Courbe de montage 55 m portée • Curva di montaggio 55 m sbraccio • Curva de montaje 55 m alcances • Curva de montagem 55 m alcance • Увеличенная монтажная 55 м Вылет

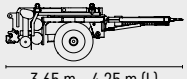
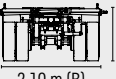
Kolli-Liste • Packing List • Liste de colisage • Lista dei colli • Lista de contenido Lista de embalagem • Упаковочный лист

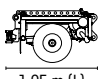
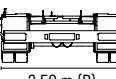
P ₁	A ₁	Beschreibung • Description • Description • Descrizione • Descripción • Descrição • Описание				
1 2	4 2'	Turmstück (ohne/mit Turmauflage) • Tower section (without/with tower support) • Élément de mât (sans/avec support de mât) • Elemento di torre (senza/con pedana di servizio) • Tramo de torre (sin/con soporte de torre) • ramo de torre (sem/com suporte de torre) • Башенная секция (без/с опорными выступами)				
			L (m)	B (m)	H (m)	kg
			2,55 2,55	1,10 1,10	0,95 0,95	650 850*
3	1	Ausleger-Verlängerung 35,0 m – 40,0 m • Jib extension • Rallonge de la flèche • Elemento estensiono braccio • Prolongación de pluma • Extensão da lança • Удлинение стрелы				
			5,50 m (L)	0,95 m (B)	1,05 m (H)	
			📦 330 kg			

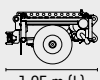
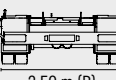
P₁ = Position • Item • Position • Posizione • Posición • Posição • Положение A₁ = Anzahl • Quantity • Nombre • Numero • Cantidad • Número • Количество

P ₁	A ₁	Beschreibung · Description · Description · Descrizione · Descripción · Descrição · Описание					
4	1	Ausleger-Verlängerung 40,0 m – 45,0 m · Jib extension Rallonge de la flèche · Elemento estensione braccio Prolongación de pluma · Extensão da lança · Удлинение стрелы		5,20 m (L)		0,95 m (H) 0,95 m (B)	 200 kg
5	1	Ausleger-Verlängerung 45,0 m – 50,0 m · Jib extension Rallonge de la flèche · Elemento estensione braccio Prolongación de pluma · Extensão da lança · Удлинение стрелы		5,20 m (L)		0,75 m (H) 0,95 m (B)	 160 kg
6	1	Ausleger-Verlängerung 50,0 m – 55,0 m · Jib extension Rallonge de la flèche · Elemento estensione braccio Prolongación de pluma · Extensão da lança · Удлинение стрелы		5,85 m (L)		0,65 m (H) 0,95 m (B)	 130 kg
7	1	Kabine · Cabin · Cabine · Cabina · Cabina · Cabina · Кабина		2,65 m (L)		2,50 m (H) 2,00 m (B)	 900 kg
8	1	Transportachse vorne · Road transport axle front Essieux de transport avant · Asse di trasporto anteriore Eje delantero para transporte · Eixo de transporte dianteiro Транспортировочная ось, передняя		L		H	
				L (m)	B (m)	H (m)	kg
		Tra 100 KY 6		3,65 -	1,45	1,10	920
		Tra 100 KY 6 A		4,15			920
9	1	Transportachse hinten Tra 204 · Road transport axle behind Essieux de transport arrière · Asse di trasporto posteriore Eje trasero para transporte · Eixo de transporte traseiro Транспортировочная ось, задняя		3,10 m (L)		1,10 m (H) 2,50 m (B)	 1900 kg
10	1	Transportachse vorne LiTRAX HS-121 · Road transport axle front Essieux de transport avant · Asse di trasporto anteriore Eje delantero para transporte · Eixo de transporte dianteiro Транспортировочная ось, передняя		3,65 m - 4,25 m (L)		1,15 m (H) 2,10 m (B)	 1900 kg
11	1	Transportachse hinten LiTRAX HS-122 (ohne Lenkung) · Road transport axle behind (without steering) Essieux de transport arrière (sans direction) Asse di trasporto posteriore (senza sterzo) · Eje trasero para transporte (sin sistema de dirección) · Eixo de transporte traseiro (sem esterço) Транспортировочная ось, задняя (без управления)		1,95 m (L)		1,10 m (H) 2,50 m (B)	 1600 kg
12	1	Transportachse hinten LiTRAX HS-123 (mit Lenkung) · Road transport axle behind (with steering) Essieux de transport arrière (avec direction) Asse di trasporto posteriore (con sterzo) · Eje trasero para transporte (con sistema de dirección) · Eixo de transporte traseiro (com esterço) Транспортировочная ось, задняя (с управлением)		1,95 m (L)		1,10 m (H) 2,50 m (B)	 1700 kg

P₁ = Position · Item · Position · Posizione · Posición · Posição · Положение A₁ = Anzahl · Quantity · Nombre · Numero · Cantidad · Número · Количество

Sämtliche Angaben erfolgen ohne Gewähr.

This information is supplied without liability.

Ces renseignements sont sans garantie.

Tutte le indicazioni fornite senza garanzia.

Declinamos toda responsabilidad derivada de la información proporcionada.

Declinamos qualquer responsabilidade quanto à informação fornecida.

Все данные указаны без обязательств.

Änderungen vorbehalten!

Subject to technical modifications!

Sous réserves de modifications !

Con riserva di modifiche!

¡Sujeto a modificaciones sin previo aviso!

Sujeto a modificações!

С правом внесения изменений!